

Article number: 2310431079

Description: E+G Levelling elements
LX.30-SW17-M10X71

Measures

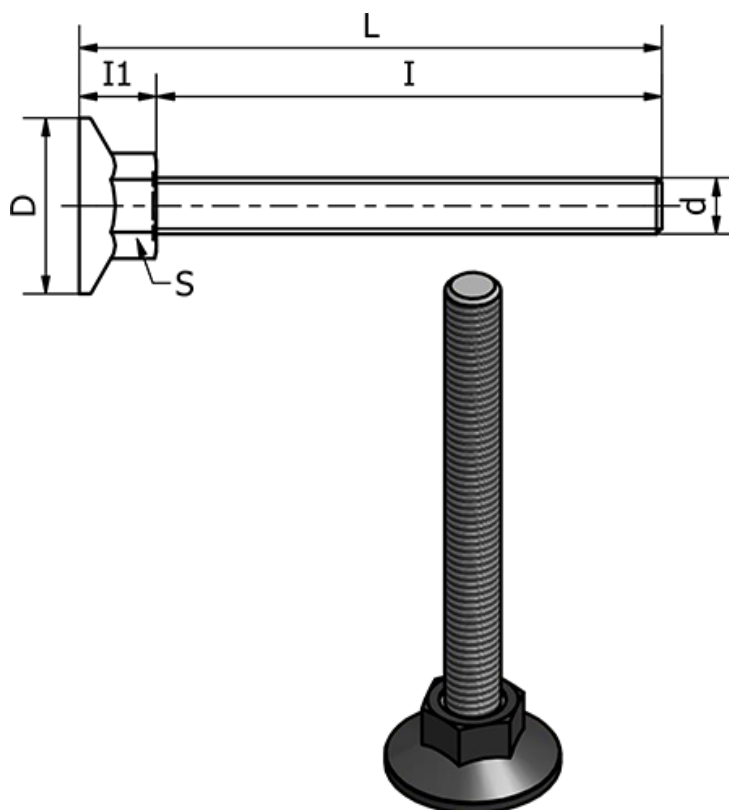

d = M10

D = 30

I = 71

I1 = 12

L = 83

S = 17

Static load in (N) = 3000

Type = Forzinket

Weight (g) = -